

Energy Economics, Winter Semester 2022-3

Lecture 9: The Electricity Grid

Prof. Tom Brown, Philipp Glaum

[Department of Digital Transformation in Energy Systems](#), Institute of Energy Technology, TU Berlin

Unless otherwise stated, graphics and text are Copyright © Tom Brown, 2022-3. Graphics and text for which no other attribution are given are licensed under a Creative Commons Attribution 4.0 International Licence. 

1. Introduction to Grid Congestion
2. Trading Between Regions
3. Redispatch
4. Balancing Power
5. Distribution Grids
6. Network Fees

Introduction to Grid Congestion

Lecture 3: Benefits of Trade

Thus far we have looked at electricity markets in **isolation** from each other, while also **ignoring grid physics**.

Recall: Trade between 2 regions always leads to a **welfare gain** (WFG) in each country, but can have a strong influence on the distribution between the consumer and producer surpluses.

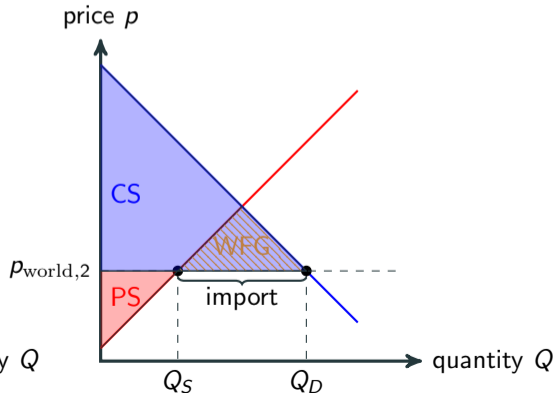
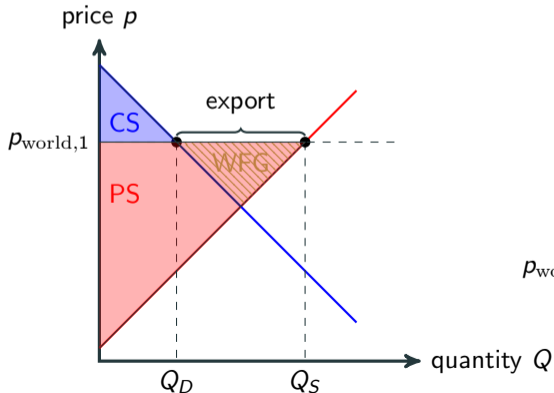

Lecture 4: Electricity grids: technical overview

Grid takes electricity from generators to consumers. Long distance transport: **transmission network** at high voltages (> 110 kV). Shorter distance transport: **distribution network** at lower voltages (≤ 110 kV). In houses usually 230 V.

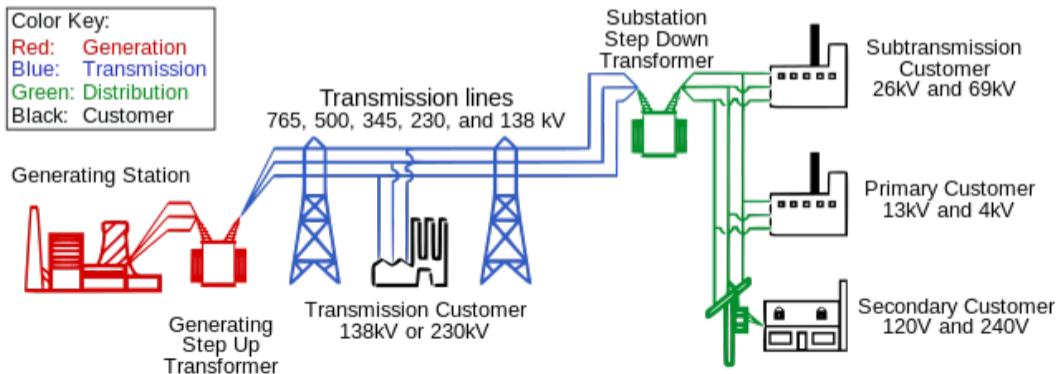

Lecture 4: Electricity grids: technical overview

The European transmission network is mostly at 220 kV (green) and 380 kV (red). Purple lines are undersea high voltage direct current (HVDC) cables.

The capacity of each transmission line is **constrained** because of thermal and voltage limits.

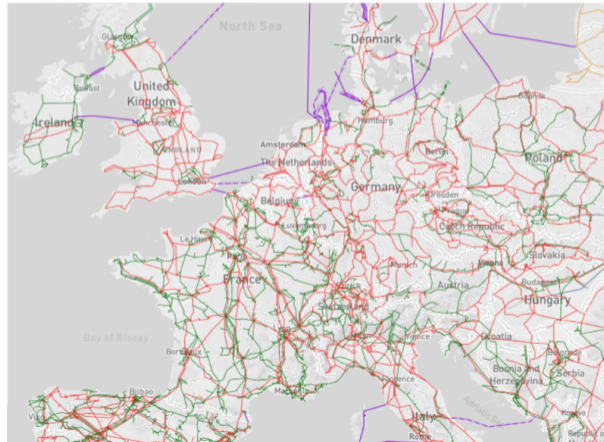

Lecture 4: What happens when things go wrong

In November 2006, the continental European system split into three parts. Since before the split 10 GW was being transferred from East to West, in the West there was a generation deficit, which caused a frequency drop, while in the East there was an oversupply, causing a frequency spike.

- Area 1 under-frequency
- Area 2 over-frequency
- Area 3 under-frequency

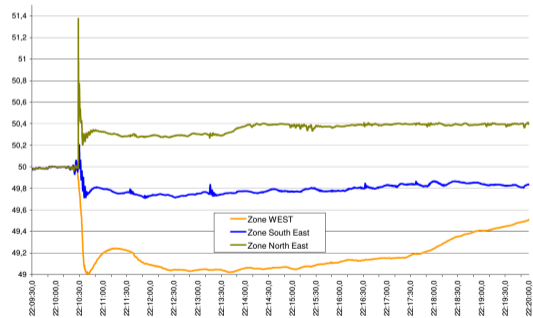
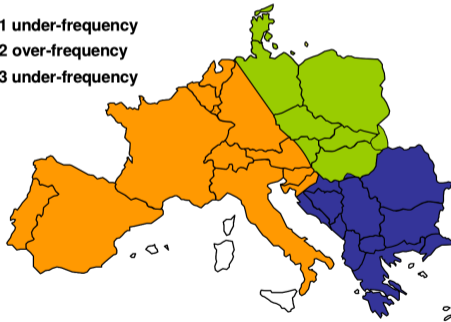

- How can we take account of trade between regions in electricity markets?
- How do we deal with grid constraints between regions?
- How do we deal with grid constraints within regions?
- What incentives are there for grid operators to expand their networks?
- How do we incentivise the provision of grid services (frequency regulation, voltage stability, black start capability, covering resistive losses)?

Trading Between Regions



- Bids for German electricity take place in a **bidding zone** encompassing both Germany and Luxembourg (Austria was separated from the German bidding zone in October 2018)
- Other countries have their own bidding zones or are **split** into several bidding zones (see Nordic countries and Italy)
- This means that transmission constraints are only visible to the market at the **borders** between the bidding zones
- Internal transmission constraints are **ignored** - market bids are handled as if they do not exist (see next section on congestion management)

Goal: Creation of a single market for electricity in Europe.

Benefits are numerous:

- **Increase in overall welfare** since low-cost regions can export to high-cost regions
- **Level out price differences** between bidding zones
- **Strengthen competition** between suppliers
- **Economies of scale** for power plants
- Improve **system integration** of variable RES (balance variable feed-in over larger area, allow integration of best wind and solar sites)
- Improve **network security** by sharing system service resources (e.g. control power)
- **Backup generation** available in case of a power plant failure
- More **uniform aggregated load** leads to more regular power plant operation

But: Technical constraints lead to **congestion**.

Congestion occurs when a market transaction between two regions is limited by the technical exchange capacity between the regions.

Adequate allocation of the scarce resource of transmission capacity is called **congestion management**.

Pre-emptive measures:

- **Explicit auctions** of capacity between bidding zones
- **Implicit auctions** of capacity between bidding zones

Curative measures:

- **Redispatch** of power plants within the bidding zones

Capacity constraints between bidding zones

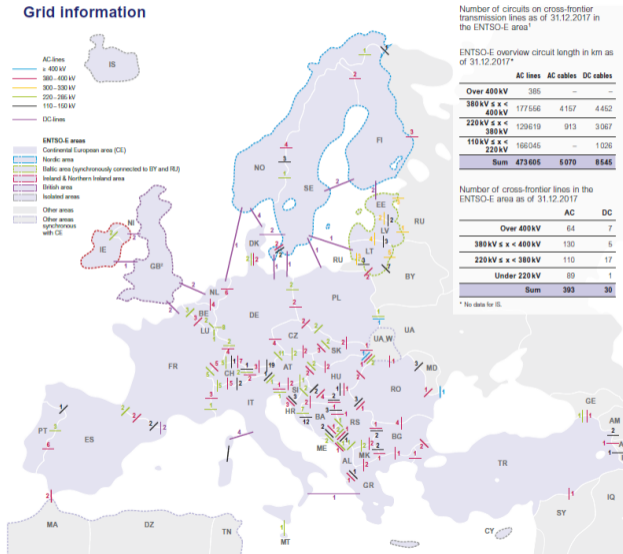

- **Capacity constraints** between bidding zones are determined for each border depending on capacities at the border and any other limiting transmission lines inside each bidding zone
- Capacities can be **different** in different directions (exports versus imports)
- Some borders have alternating current (AC) and some direct current (DC)
- Central and Western Europe has more advanced **flow-based market coupling**

- If the price between two or more bidding zones is not the same, **arbitrage** is possible (buying power in the lower-cost zone and selling it in the higher-cost zone)
- If there is no limit on trade, prices will **equalise**
- However, trade is typically **limited by interconnection capacity**
- If the interconnection capacity is limited, prices may not equalise, giving rise to **congestion rent**, which is the price difference multiplied by the flow of electricity between the regions

Trading without congestion caused by transmission constraints

Before trading, the price in Market A, PA , is lower than that in Market B, PB .

After trading, Market A exports to B and the prices equalise $PA^* = PB^*$.

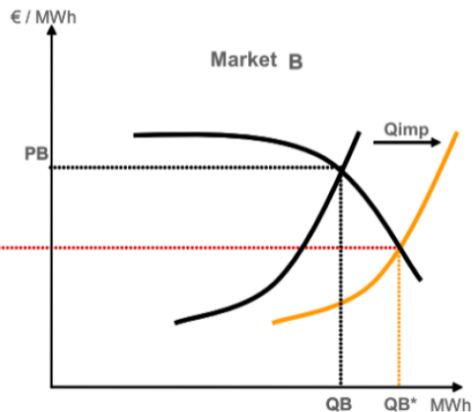
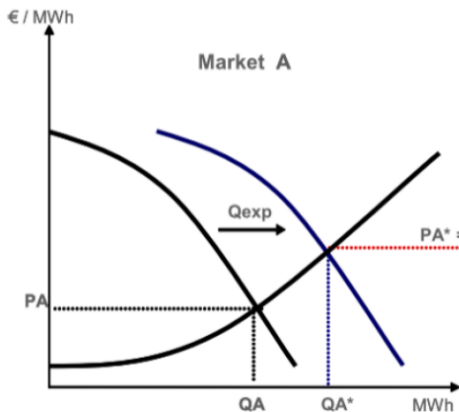

Quelle:
Epex Spot
SE

Exporting Market

Importing Market

Trading with congestion caused by transmission constraints

If a transmission line causes a capacity constraint that limits price arbitrage, prices converge but do not equalise. We have **congestion**. The product of the flow and the price difference is the **congestion rent**, $\Delta P \cdot F$. (ATC is the **Available Transmission Capacity**.)

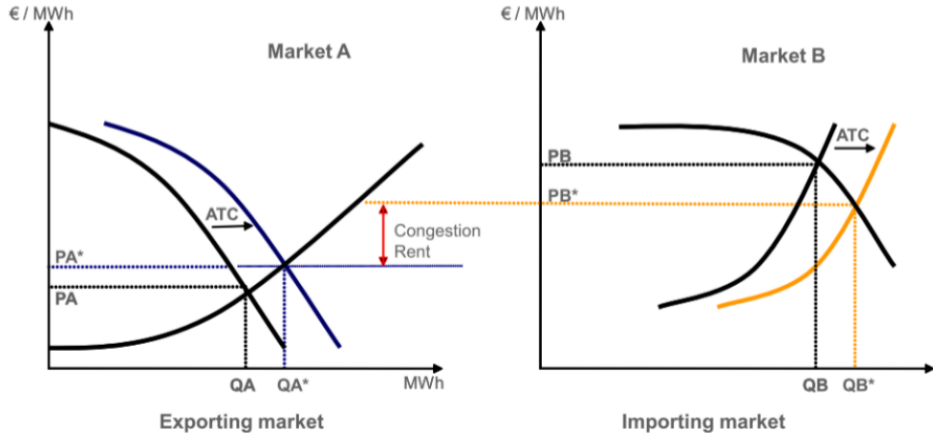

Trading will cause prices to converge over time.

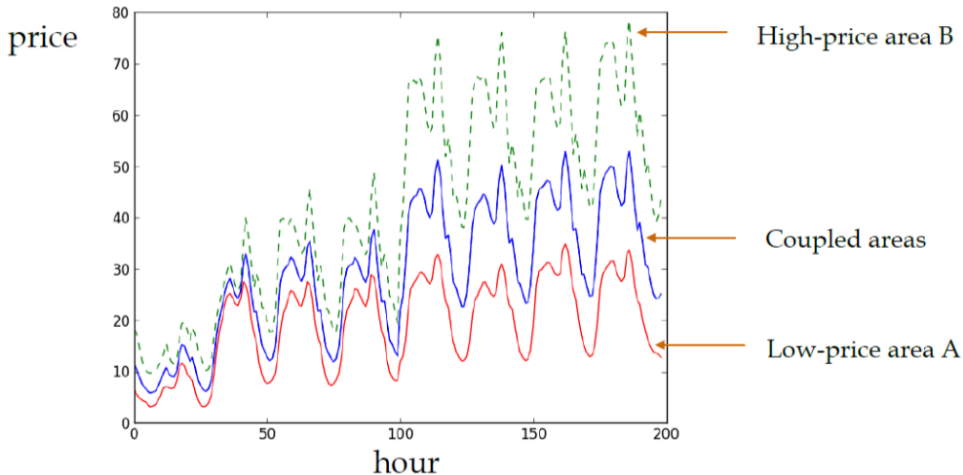

Example: two nodes with completely inelastic demand

Now consider the connection of two nodes i with their own electricity supply curves $P_i(Q_i)$ and **completely inelastic demand** (i.e. a vertical demand curve) Q_i^B , with a line with capacity K .



Node 1

demand: $Q_1^B = 500$ MW

supply: $P_1(Q_1) = 10 + 0.01 \cdot Q_1$

Node 2

demand: $Q_2^B = 1500$ MW

supply: $P_2(Q_2) = 13 + 0.02 \cdot Q_2$

Note that electricity is cheaper at node 1 than node 2.

We can determine the flow exported from node 1 and imported to node 2:

$$F = Q_1 - Q_1^B = Q_2^B - Q_2$$

Case 1: no transmission capacity $K = 0$

First suppose there is no transmission capacity between the nodes, $K = 0$. This is the same as having separate markets.

For each node i we have demand equal to supply

$$Q_i = Q_i^B$$

The price at each node is set by the intersection of the (vertical) demand curve and the supply curve.

For the first node $Q_1^B = 500$ so the price is

$$P_1(Q_1^B) = P_1(500) = 10 + 0.01 \cdot 500 = 15$$

For the second node $Q_2^B = 1500$ so the price is

$$P_2(Q_2^B) = P_2(1500) = 13 + 0.02 \cdot 1500 = 43$$

Case 1: no transmission capacity $K = 0$

We can draw this on a single graph by plotting the supply curve for node 1 from the left axis, and the supply curve from node 2 from the right axis. We will always have (regardless of transmission)

$$Q_1^B + Q_2^B = Q_1 + Q_2 = 2000$$

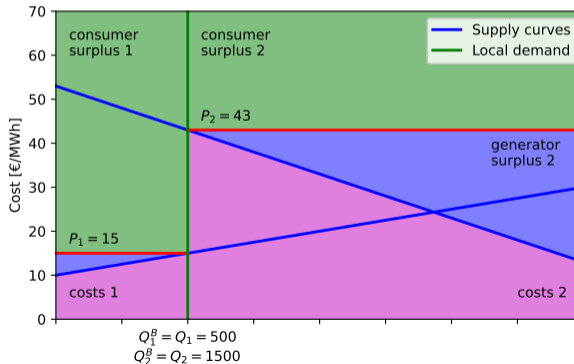

Now suppose there is unlimited transmission, so that the two markets merge. Now there is a single demand $Q_1 + Q_2 = 2000$ and a single clearing price. The generators adjust their output until the prices equalise:

$$P_1(Q_1) = P_2(Q_2) = P_2(2000 - Q_1)$$

We solve this to find Q_1 :

$$10 + 0.01 \cdot Q_1 = 13 + 0.02 \cdot (2000 - Q_1)$$

$\Rightarrow 0.03 \cdot Q_1 = 43 \Rightarrow Q_1 = 1433$ MW, $Q_2 = 2000 - Q_1 = 567$ MW and the common clearing price is $P = P_1(Q_1) = P_2(Q_2) = 24.33$ €/MWh.

Case 2: unlimited transmission capacity $K = \infty$

We can draw this on our graph, but now the transmission means $Q_i \neq Q_i^B$ since node 1 exports electricity to node 2. The power flow F from node 1 to 2 is

$$F = (Q_1 - Q_1^B) = - (Q_2 - Q_2^B) = (1433 - 500) = - (567 - 1500) = 933$$

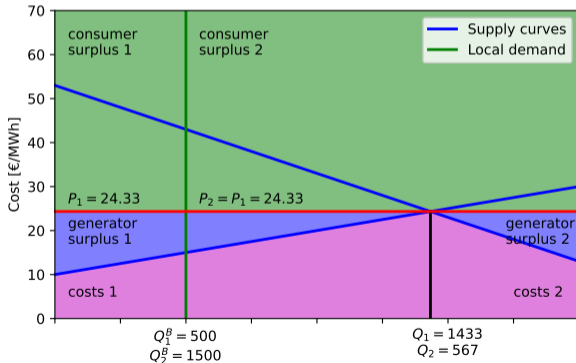

Now suppose the transmission capacity is less than the power flow occurring for a single market with unconstrained transmission. The (cheaper) generators at node 1 export power until the line is **congested**. The (more expensive) generators then cover the remaining load at node 2.

We find two separate prices:

$$P_1(Q_1^B + K) = P_1(500 + 400) = 10 + 0.01 \cdot 900 = 19$$

$$P_2(Q_2^B - K) = P_2(1500 - 400) = 13 + 0.02 \cdot 1100 = 35$$

This leads to $Q_1 = 900$ MW, $P_1 = 19$ €/MWh, $Q_2 = 1100$ MW, $P_2 = 35$ €/MWh and flow equal to capacity $F = K = 400$ MW.

Case 2: constrained transmission capacity $K = 400$ MW

The **congestion rent** is now visible in the middle (flow times price difference), since there is welfare which is neither generator nor consumer surplus.

This money goes to the network operator for providing the arbitrage opportunity via the network.

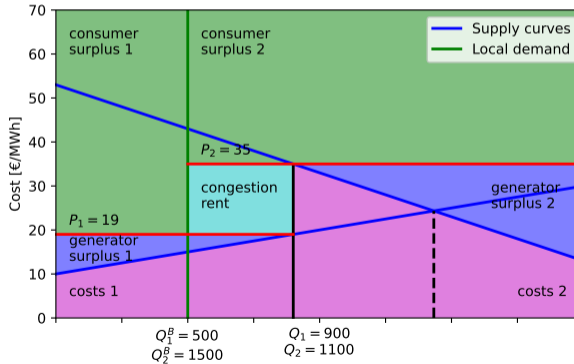

Outcomes for different values of transmission capacity K

$$K = 0, F = 0,$$

$$Q_1^* = 500, Q_2^* = 1500$$

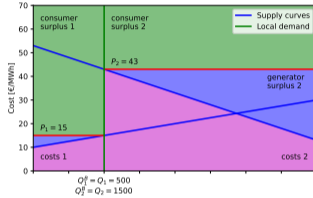

$$K = \infty, F = 933$$

$$Q_1^* = 1433, Q_2^* = 567$$

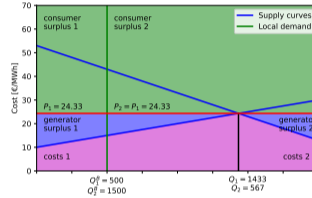

$$K = 400, F = 400$$

$$Q_1^* = 900, Q_2^* = 1100$$

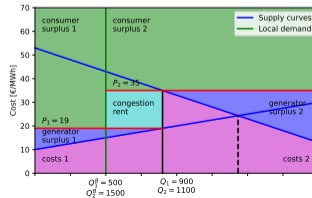

	1: Separate markets	2: Single market	3: Constrained market
Q_1^B [MW]	500	500	500
Q_1 [MW]	500	1433	900
P_1 [€/MWh]	15	24.33	19
Q_2^B [MW]	1500	1500	1500
Q_2 [MW]	1500	567	1100
P_2 [€/MWh]	43	24.33	35
$F_{1 \rightarrow 2}$ [MW]	0	933	400
$\sum_i P_i \times Q_i$ [€/h]	72000	48660	55600
$\sum_i P_i \times Q_i^B$ [€/h]	72000	48660	62000
$(P_2 - P_1) * F_{1 \rightarrow 2}$ [€/h]	0	0	6400

Due to the congestion of the transmission line, the marginal cost of producing electricity is different at node 1 and node 2. The competitive price at node 2 is higher than at node 1.

Since consumers pay and generators get paid the price in their local market, in case of congestion there is a difference between the total payment of consumers and the total revenue of producers – this is the **merchandising surplus** or **congestion rent**, collected by the transmission system operator. For each line it is given by the price difference in both regions times the amount of power flow between them:

$$\text{Congestion rent} = \Delta P \times F$$

Example: Congestion rent for different values of K

The congestion rent for the two-node example is given by

$$\text{Congestion rent} = |P_1 - P_2| \times |F|$$

It is also the difference between consumer payments and generator revenues.

As a function of K it reaches a maximum between the two extremes of no capacity and unlimited capacity:

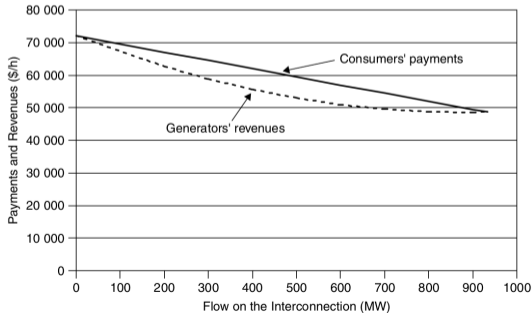

Goal: efficient allocation of cross-border transmission capacities in order to optimise social welfare.

Explicit auction: transmission rights are auctioned separately and independently from the electricity market.

- annual, monthly and daily auctions
- bilaterally or via exchange

Implicit auction: transmission rights and energy are coupled and traded simultaneously (i.e. buyers bid for electricity supplied by generators from the neighbouring market area). The price per area reflects both the cost of energy and congestion.

- via exchange

In explicit auctions, traders sell/buy electricity and capacity separately.

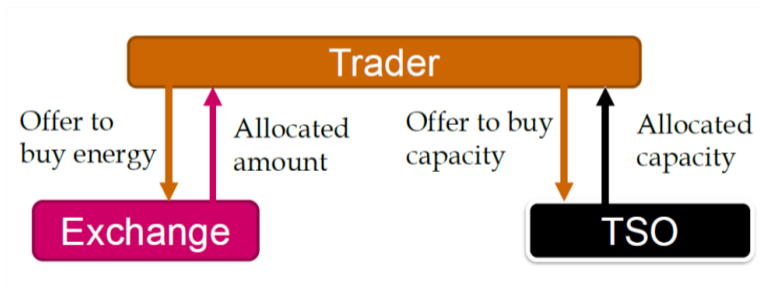

In an implicit auction, the market clearing and use of interconnection capacity is determined **simultaneously** in an algorithm which **optimises overall social welfare**. In Europe for the day ahead market this algorithm is called EUPHEMIA.

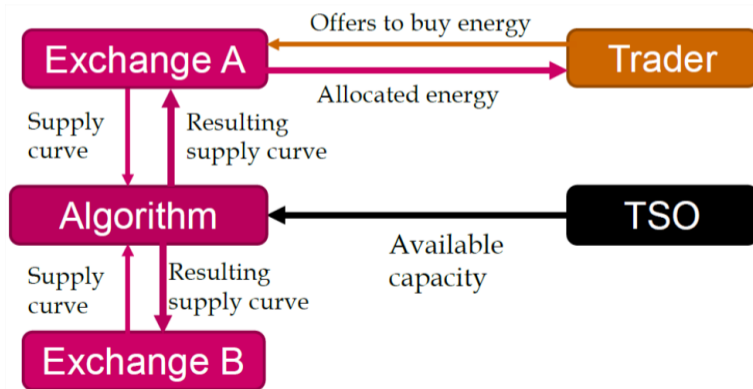

Trend from explicit to implicit auction

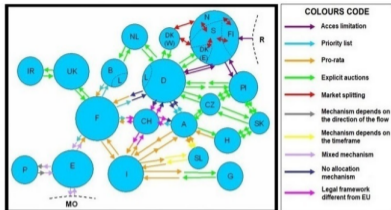

(1) Two arrows appearing in the same flow sense in a certain interconnection mean that, for that interconnection in that flow sense, there is not a unique capacity allocation method or congestion management mechanism jointly applied by the two TSOs involved.

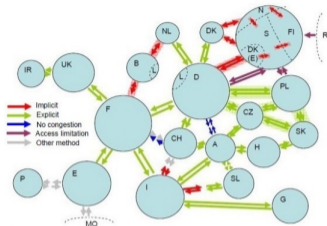

- Top left: day-ahead coupling in 2003.
- Top right: day-ahead coupling in 2007.
- Bottom left: day-ahead coupling in 2021 (borders in yellow not coupled).
- Bottom right: intraday coupling over time.

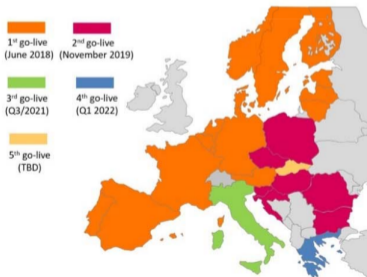

Redispatch

The Problem: Congestion inside bidding zones

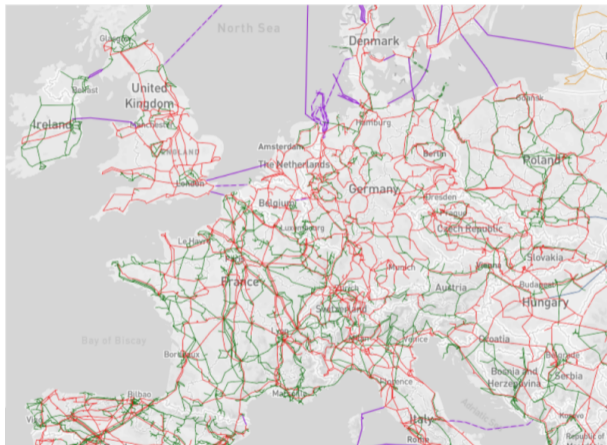

- The country-sized and regional bidding zones ignore congestion **inside** the bidding zones.
- The bidding zone is defined by assuming no congestion inside its borders.
- However, the resulting market dispatch can still lead to violations of transmission capacity inside the zone.
- Counter-measures: **redispatch** outside the market.

The problem is exacerbated by wind and solar

Renewables are not always located near demand centres, as in this example from Germany.

Load distribution

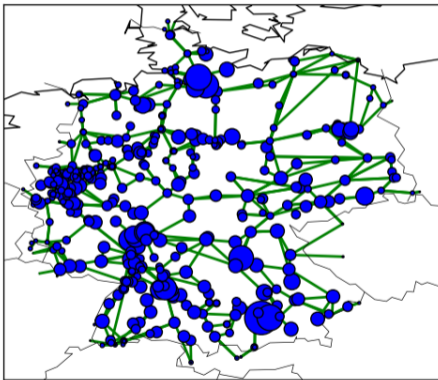

Wind Onshore

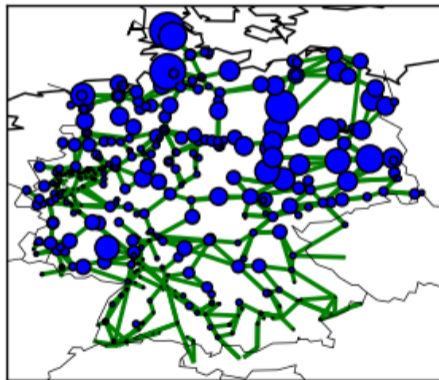



- This leads to **overloaded lines** in the middle of Germany, which cannot transport all the wind energy from North Germany to the load in South Germany
- It also overloads lines in neighbouring countries due to **loop flows** (unplanned physical flows 'according to least resistance' which do not correspond to traded flows)
- It also **blocks imports and exports** with neighbouring countries, e.g. Denmark

Scheduled market flows versus physical flows

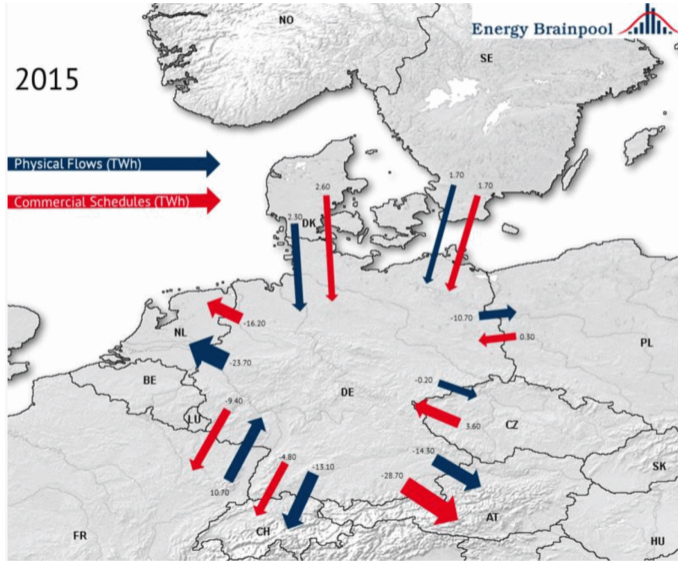

Power traded between zones (“scheduled flows”, red) does not always correspond to what flows according to the network physics (“physical flows”, blue). This leads to political tension as wind from Northern Germany flows to Southern Germany via Poland and the Czech Republic as a **loop flow** rather than flowing inside Germany as intended.

These problems are **not visible** in the day-ahead electricity market, which treats the whole of Germany as a single bidding zone. It dispatches wind in North Germany as if there was no internal congestion...

To ensure that the physical limits of transmission are not exceeded, the network operator must **'re-dispatch'** power stations and **curtail** (Einspeisemanagement) renewables to restore order. This is **costly** (0.8 redispatch + 0.6 RE-compensation = 1.4 billion EUR in 2017 - although exceptional circumstances in 1st quarter) and results in **lost CO₂-free generation** (5.5 TWh curtailment of RE and CHP in 2017).

International redispatch is sometimes also required (Multilateral Remedial Actions = MRA).

Furthermore, there are **no market incentives** to reinforce the North-South grid, to locate more power stations in South Germany or to build storage / P2X in North Germany.

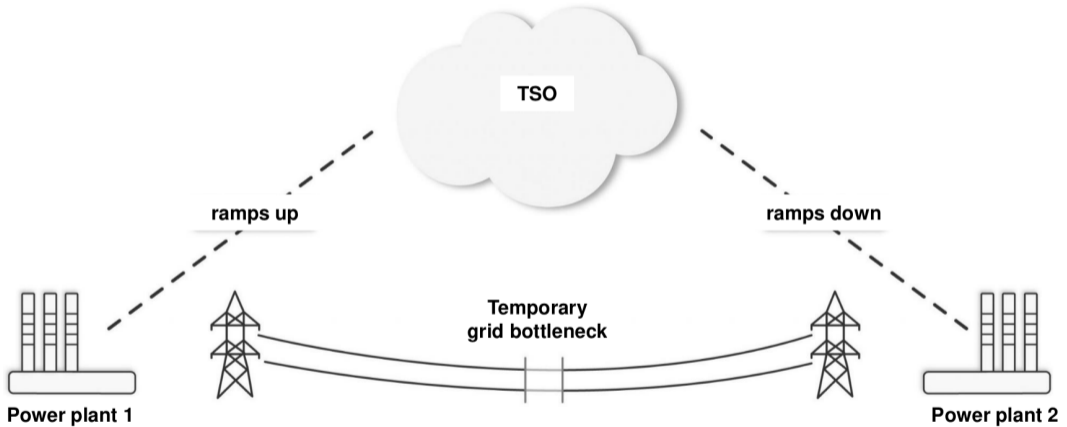

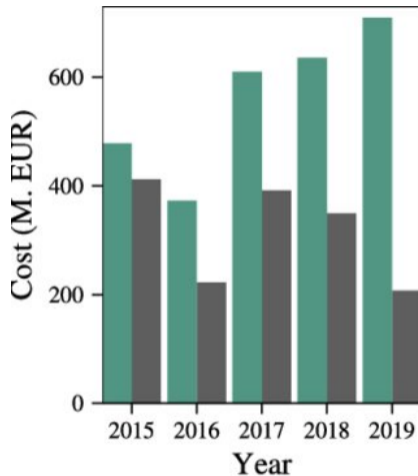

(a) Expenditure

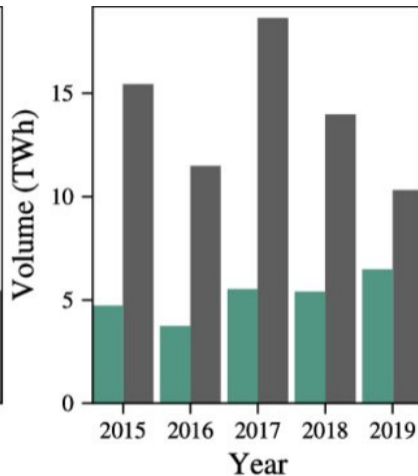

(b) Volume

From October 2021 redispatch was reformed in Germany in NABEG 2.0. Before it was distinguished between redispatch (for conventional power stations) and curtailment (for renewables and CHP).

The goal of the new legislation is:

- To put conventionals and renewables on same footing (both can participate in redispatch)
- Also involve units attached to the distribution grid (units above 100 kW or those already that can be controlled)

Sometimes redispatch actions within the bidding zone are not sufficient.

Here there are two options (much rarer than redispatch):

- **Counter-trading**: Transmission system operators buy power in one bidding zone and sell in another on the power exchanges to reduce a bottleneck either on the border or inside the bidding zone.
- **Multilateral Remedial Action (MRA)**: Post-market redispatch involving multiple bidding zones.

Solution 2: Grid expansion within bidding zones

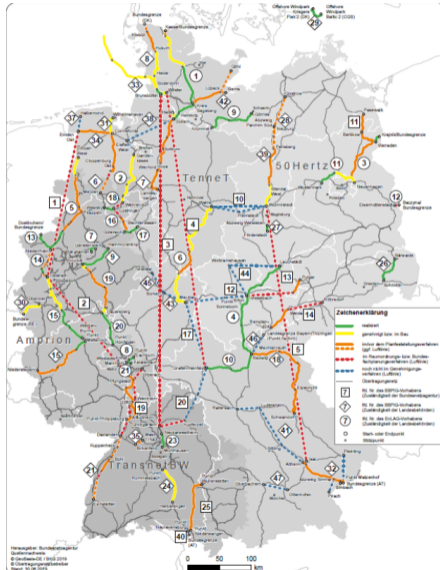

- Relieve congestion by expanding capacities inside the bidding zone
- Investment increases money TSOs can claim via network fee on consumers
- Regulator (Bundesnetzagentur) must approve the grid expansion plans

Solution 3: Smaller bidding zones to “see” congested boundaries



- In Scandinavia they have solved this by introducing **smaller bidding zones**
- Now congestion at the boundaries between zones is taken into account in the **implicit auctions** of the market
- This is also done in Italy (again, a long country), where prices for small consumers are **uniformised** for fairness

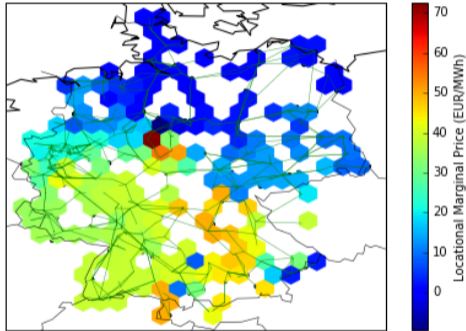

- The ultimate solution, as used in the US and other markets, is **nodal pricing**, which exposes all transmission congestion
- Considered too complex and subject to market power to be used in Europe, but this is questionable...
- Here we see clearly why many argue for a North-South German split

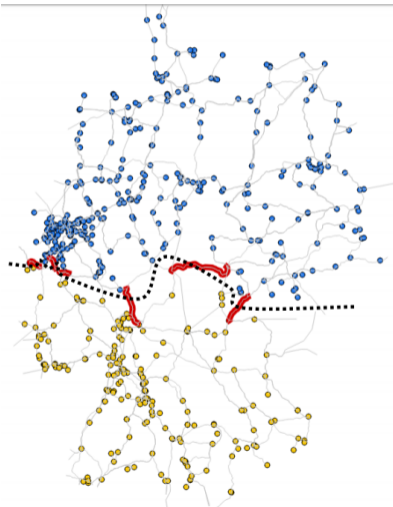

- Initial price difference could average up to 12 EUR/MWh
- Prices would converge with more network expansion
- Redispatch costs reduced by 39% in 2025, 58% in 2035 (assuming NEP 2030 transmission projects get built)
- Politically difficult, may require, like Italy, uniformised price on consumer side

Solution 1.5: Flow-based market coupling

Flow-based market coupling can be used in zonal markets to see precise individual line constraints, instead of “boxing” the feasible space like ATC/NTC schemes do.

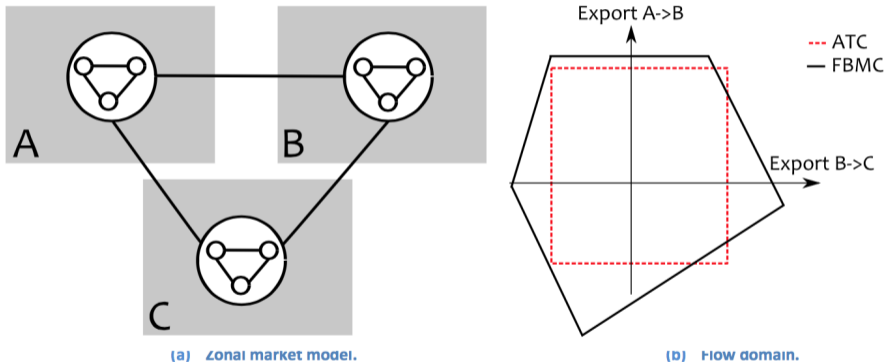

Figure 4. In the FBMC method, only one equivalent node per zone is considered, but all (critical) lines are taken into account. In this simple grid, the zonal network consists of 3 nodes and 12 lines. The FBMC flow domain is larger than the ATC flow domain as the physical characteristics of the grid are better represented in the FBMC method.



- From May 2015 to early 2022 flow-based market coupling was only applied in Germany, France, Netherlands, Belgium and Luxembourg
- From mid-2022 it has been extended across northern 'Core' countries in continental Europe

Balancing Power

System services are provided by the Transmission System Operator to maintain the stability of the grid for electricity market transactions. They include:

- Frequency control
- Voltage control
- Black-start capacities for grid restoration after black-outs
- Compensation for transmission losses
- Cross-border interconnection management

General modes of provision:

- Compulsory
- Bilateral
- Tendering
- Wholesale market

Control power markets provide frequency control.

Frequency is determined by **balance of supply and demand**.

Target frequency in Europe: 50 Hz (in other parts of world, like US, it is 60 Hz)

Excessive demand → frequency drops → **positive** balancing energy is procured by TSO

Excessive generation → frequency rises → **negative** balancing energy is procured by TSO

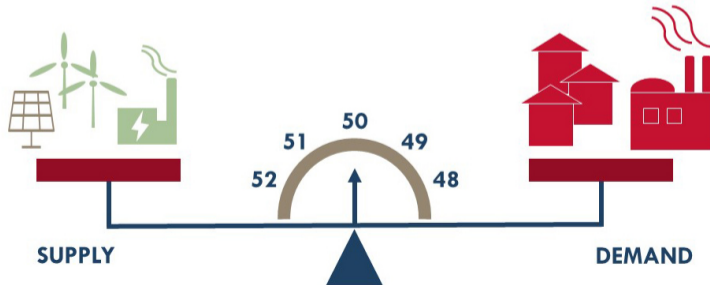

Power is scheduled in Germany on a 15-minute basis. For deviations from the schedule, **positive** control power is needed for an excess of demand, **negative** for an excess of generation.

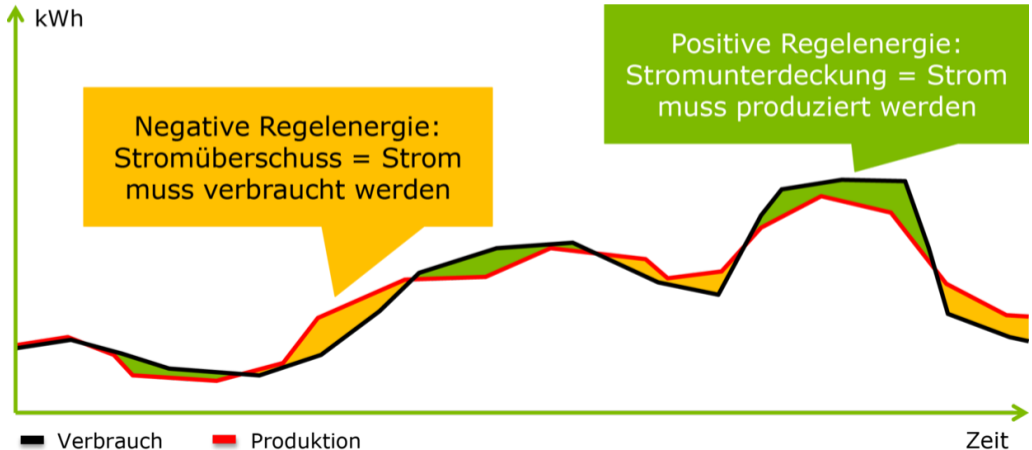

Control power is distinguished by how fast it acts.

Old terminology: **primary** for fast-acting, through **tertiary** for slow-acting.

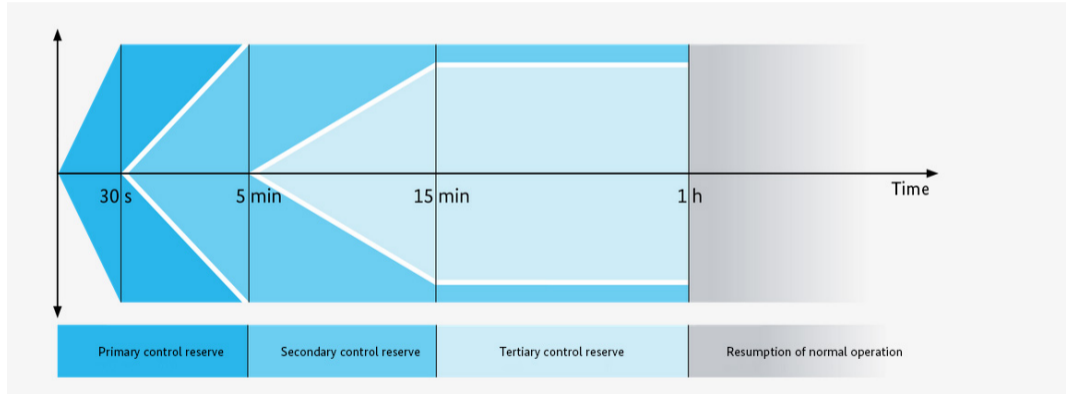

Different types of control power

Example activation during frequency excursion. New terminology: **FCR**: Frequency Containment Reserve (primary), **aFRR**: automatic Frequency Restoration Reserve (secondary), **mFRR**: manual Frequency Restoration reserve (tertiary).

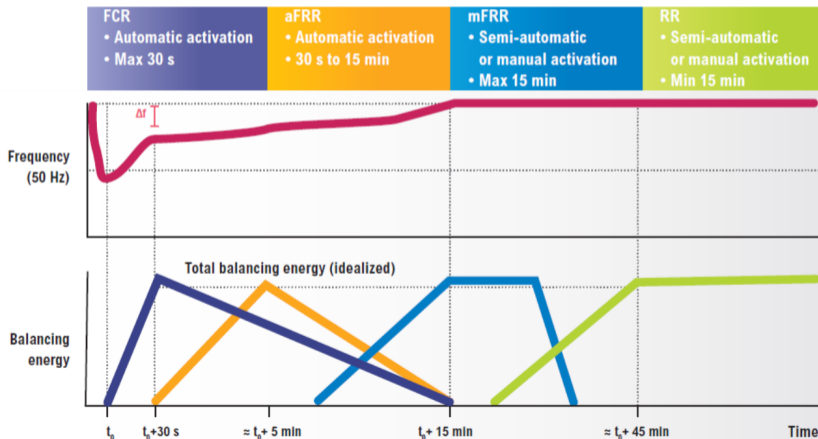

Utilisation of control power

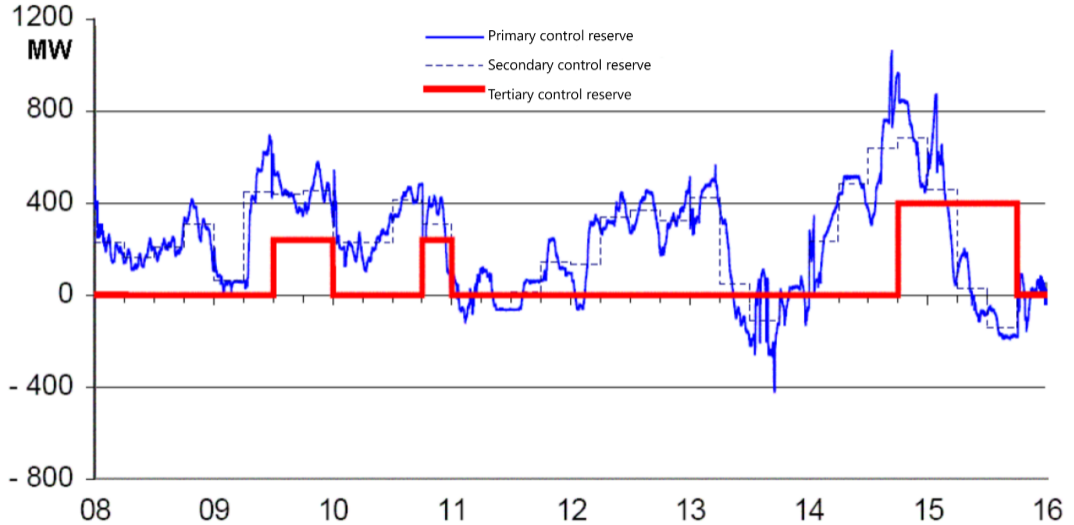

European balancing target model has following goals:

- Effective competition
- Non-discrimination
- Transparency
- Integration

European platforms and projects under development:

- IGCC, International Grid Control Cooperation – imbalance netting
- PICASSO, Platform for the International Coordination of Automated Frequency Restoration and Stable System Operation – aFRR
- MARI, Manually Activated Reserves Initiative – mFRR
- TERRE, Trans-European Restoration Reserves Exchange – RR

TSOs procure balancing power from **Balance Service Providers (BSP)** in balancing markets. Energy cost is charged to balance group.

Balance Service Providers (BSP): generators, demand response, storage.

NB: Difference between system imbalance (global) and balance group imbalance (local).

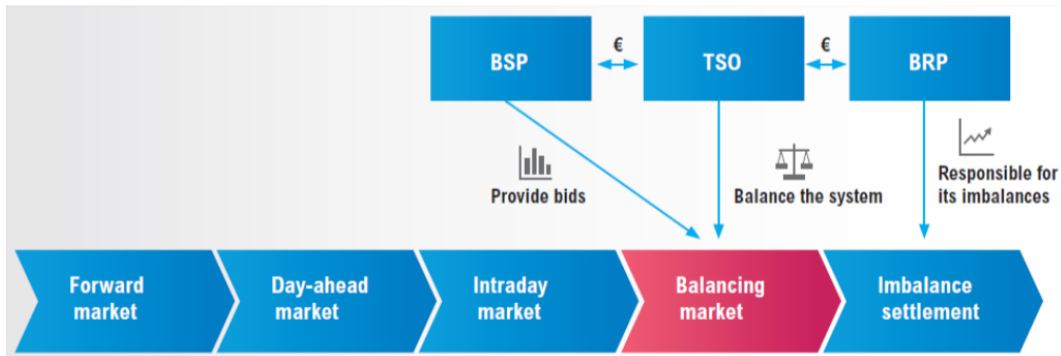

Reserves are procured in **pay-as-bid** auctions (as opposed to pay-as-clear based on marginal costs). Only capacity is procured for FCR; for FRR both capacity and energy prices are procured in completely separate markets (since 2020). You don't have to be successful in the capacity market to bid in the energy, but if you bid in capacity, you have to bid in energy.

	FCR (primary)	aFRR (secondary)	mFRR (tertiary / minute)
activation	based on frequency	automatic by TSO	manual by TSO
full power	within 30 seconds	within 5 minutes	within 15 minutes
bids	symmetric	positive or negative	positive or negative
min bid size	1 MW	5 MW	5 MW
auctions	6*4 hour slices per day	6*4 hour slices per day	6*4 hour slices per day
compensation	capacity only	capacity & energy	capacity & energy

Because there are few players and concerns about oligopoly, i.e. market power, the control power markets are **pay-as-bid**: you get paid what you bid rather than a uniform clearing price.

In theory, pay-as-bid should result in lower costs than pay-as-clear, but practice has not confirmed this.

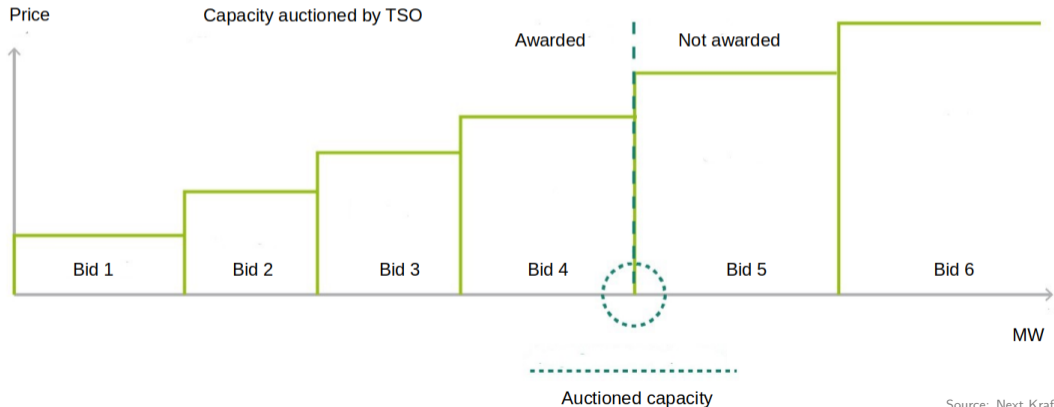

Reducing entry barriers are in focus of market design.

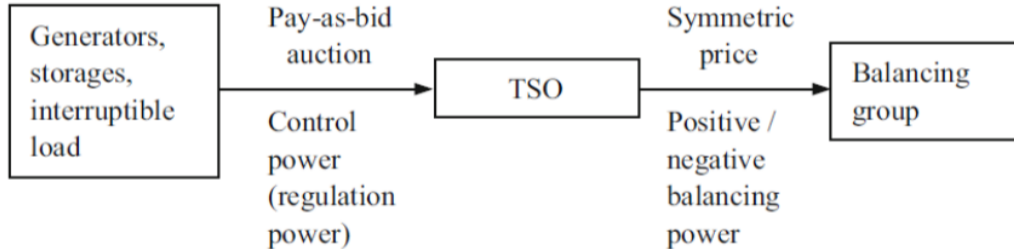

Tendered Quantities of Control Reserve in Germany / Average amount in MW per year

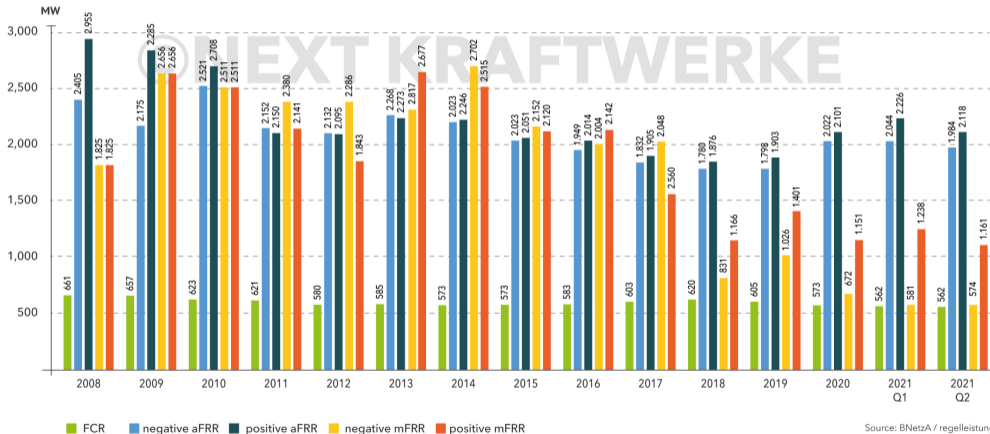

Source: BNetzA / regelleistung.net

Distinguish between **capacity price** for availability and **energy price** for utilisation.

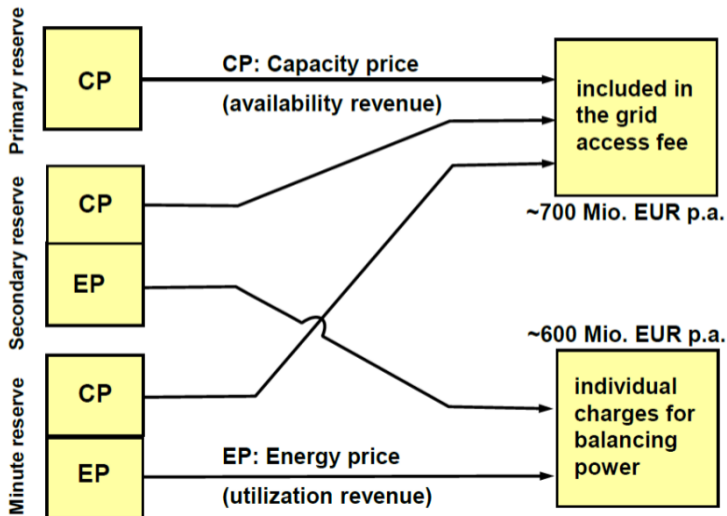

The total spent on capacity auctions (ignoring energy) has declined significantly.

Kosten der Vorhaltung von Regellenergie

in Mio. Euro

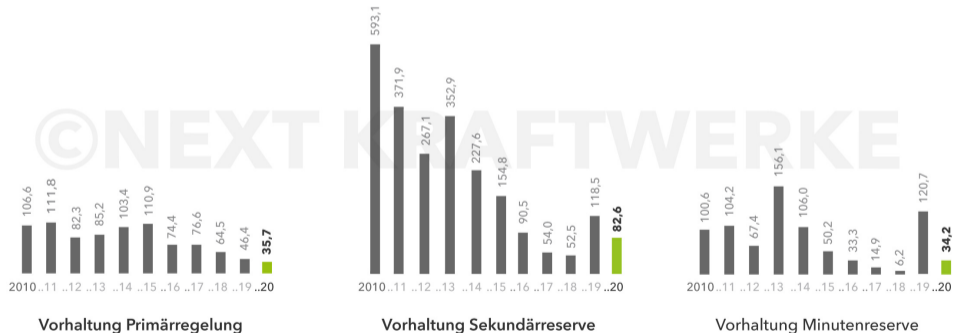

Distribution Grids

Energy transition in distribution grids

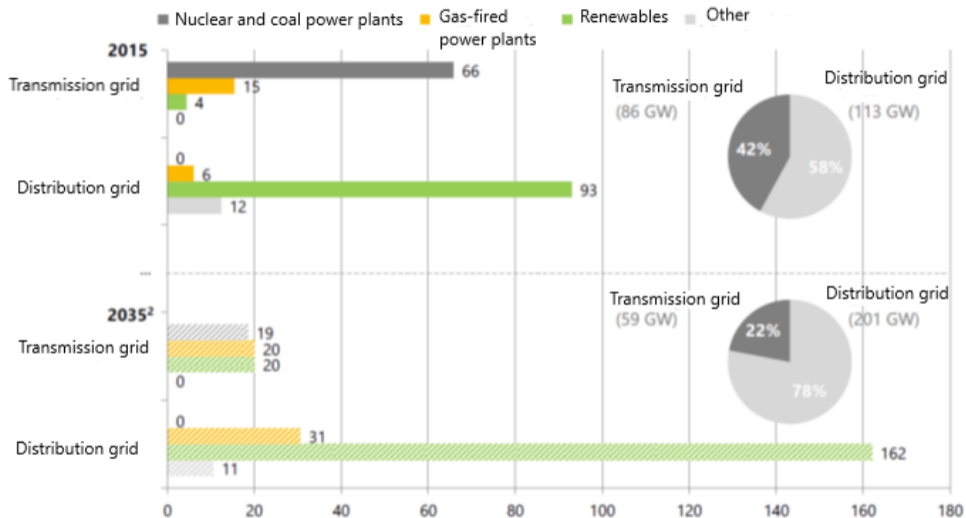

More complexity for the Distribution System Operator (DSO):

- Congestion management
- Voltage control
- Grid restoration after blackout
- (Frequency control – only in isolated systems)

Network Fees

Grid operation is a **natural monopoly**, as network infrastructure is prohibitively costly to replicate.

As any monopoly, it is prone to eliminating newcomers (potential competition for affiliated generation/retail unit) by overcharging or denying technical feasibility.

Good **regulation** should guarantee:

- **Non-discriminatory third-party access** (i.e. of generators and consumers)
- **Transparency**
- **Cost recovery** (so network operator doesn't go bankrupt)
- **Cost reflectiveness** (clear connection between charges and actual costs)

Grid tariffs must cover the following expenses of grid operators:

- Operation and Maintenance (O&M)
- Grid extension
- Control power (capacity component)
- Feed-in management (Einsman)
- Redispatch
- Grid reserve (capacity held for redispatch in South)
- Capacity reserve (for peak capacity, cannot participate in energy market now or ever)
- Security reserve (coal/climate reserve)
- Reactive power
- Grid losses
- Other

Most money goes to distribution grid level

	2010	2011	2012	2013	2014	2015	2016	2017	2018	2019*
Gesamtausgaben (in Mrd. Euro)	65,6	68,6	69,5	76,6	76,0	75,3	74,2	75,1	79,2	81,0
Staatlich induzierte Elemente	21,9	27,9	28,5	35,6	37,9	37,1	38,5	40,6	40,3	39,8
<i>Davon:</i>										
Mehrwertsteuer	4,7	4,9	5,1	5,6	5,7	5,8	5,7	6,0	5,9	6,1
Stromsteuer	6,4	7,2	7,0	7,0	6,6	6,6	6,6	6,9	6,9	6,7
Konzessionsabgabe	2,1	2,2	2,1	2,1	2,0	2,1	2,0	2,0	2,0	2,0
EEG-Umlage	8,3	13,4	14,0	19,8	22,3	22,0	22,7	24,4	24,2	22,5
Umlage nach KWKG	0,4	0,2	0,3	0,4	0,5	0,6	1,3	1,3	1,1	1,0
Offshore-Haftungsumlage und Umlage für abschaltbare Lasten	-	-	-	0,7	0,8	0,0	0,2	0,0	0,2	1,5
Staatlich regulierte Elemente	15,2	15,4	16,5	18,1	17,9	18,0	18,8	20,8	19,9	20,2
<i>Davon:</i>										
Netzentgelte Übertragungsnetz	2,2	2,2	2,6	3,0	3,1	3,5	3,8	5,3	5,7	4,9
Netzentgelte Verteilnetz	13,0	13,2	13,9	15,1	14,7	14,5	14,9	15,5	14,2	15,3
Marktgetriebene Elemente	28,5	25,3	24,5	22,9	20,2	20,2	16,9	13,7	19,0	21,0
<i>Davon:</i>										
Marktwert EEG-Strom	3,5	4,4	4,8	4,2	4,1	4,7	4,3	5,9	8,0	7,3
Erzeugung und Vertrieb	25,0	20,8	19,7	18,6	16,0	15,4	12,6	7,8	11,0	13,8

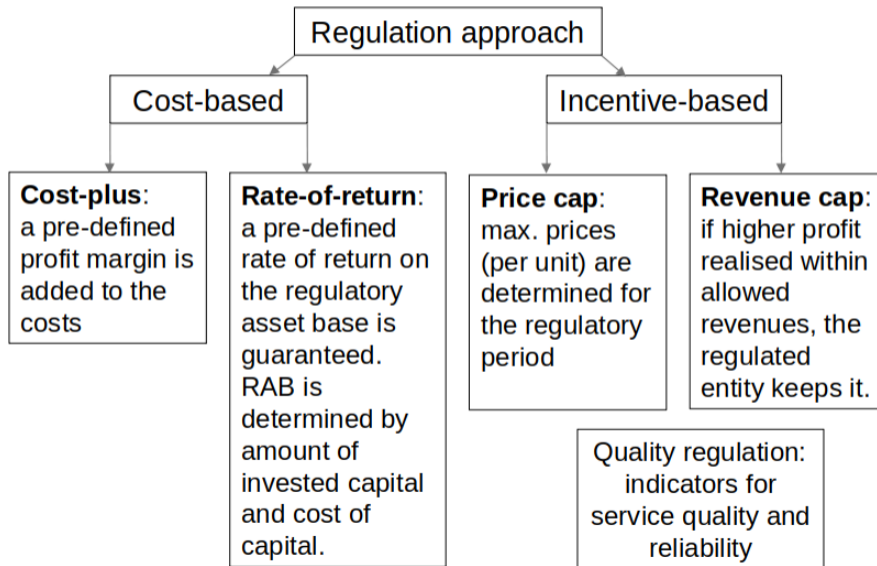

- 5-year regulatory period (current period 2019-2024)
- Revenue that TSO/DSO is allowed to earn is fixed for the regulatory period at a level.
- Revenue cap: total cost + depreciation + return on equity
- Investment costs into grid extension are allowed above cap.

Costs:

- permanently non-controllable
- temporarily non-controllable
- controllable
- volatile

Efficiency benchmarking - based on cost examination and structural data validation of individual TSO/DSO. The most efficient entity serves as benchmark.