

Energy Systems, Summer Semester 2021

Lecture 5: Networks Introduction

Prof. Tom Brown

Department of 'Digital Transformation in Energy Systems', Institute of Energy Technology

Unless otherwise stated, graphics and text are Copyright ©Tom Brown, 2021. Graphics and text for which no other attribution are given are licensed under a Creative Commons Attribution 4.0 International Licence. 

1. Single Location Versus Country Versus Continent
2. Electricity Networks

Single Location Versus Country Versus Continent

Variability: Single wind site in Berlin

Looking at the wind output of a single wind plant over two weeks, it is highly variable, frequently dropping close to zero and fluctuating strongly.

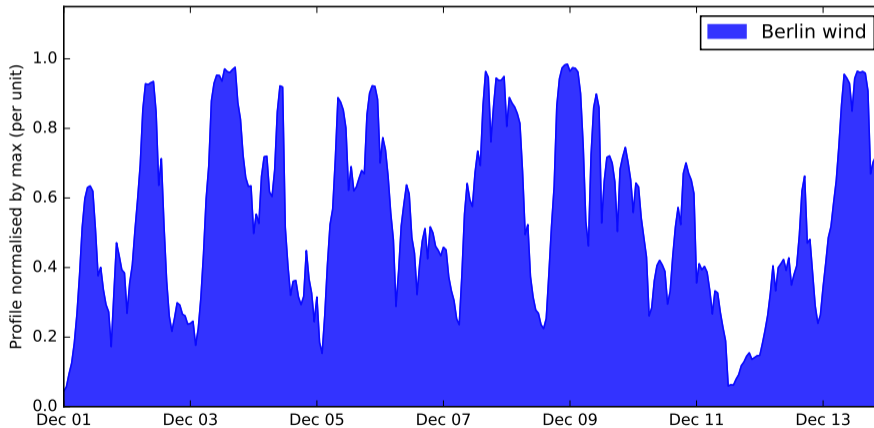

For a whole country like Germany this results in valleys and peaks that are somewhat smoother, but the profile still frequently drops close to zero.

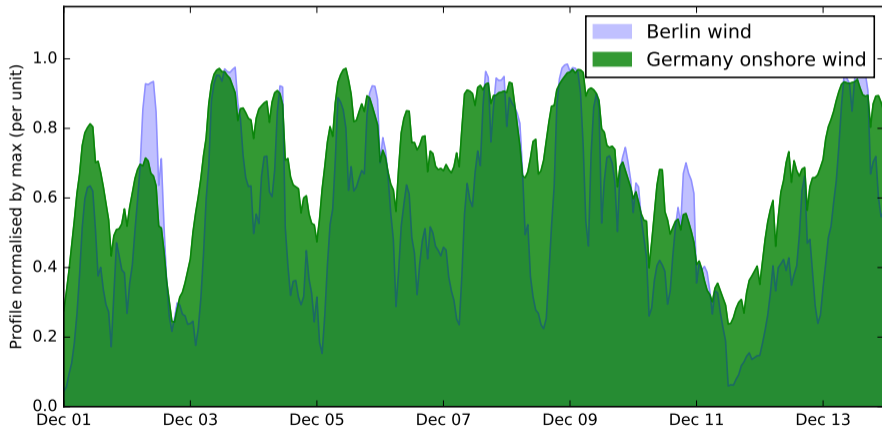

If we can integrate the feed-in of wind turbines across the European continent, the feed-in is considerably smoother: we've eliminated most valleys and peaks.

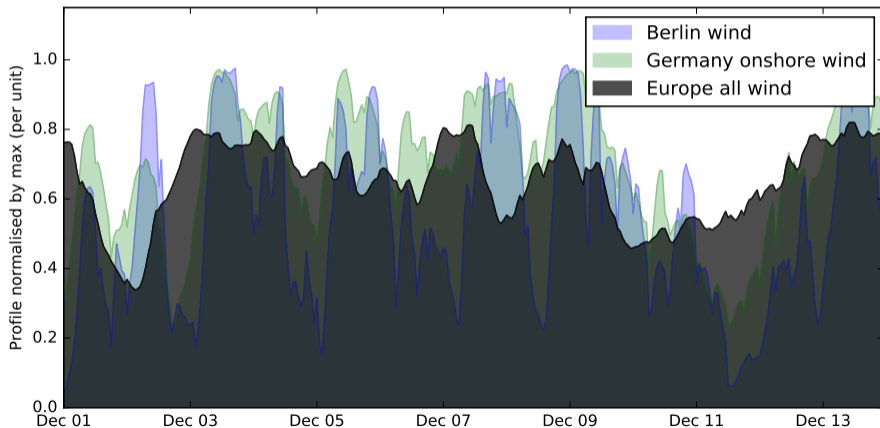

A **duration curve** shows the feed-in for the whole year, re-ordered by from highest to lowest value. For a single location there are many hours with no feed-in.

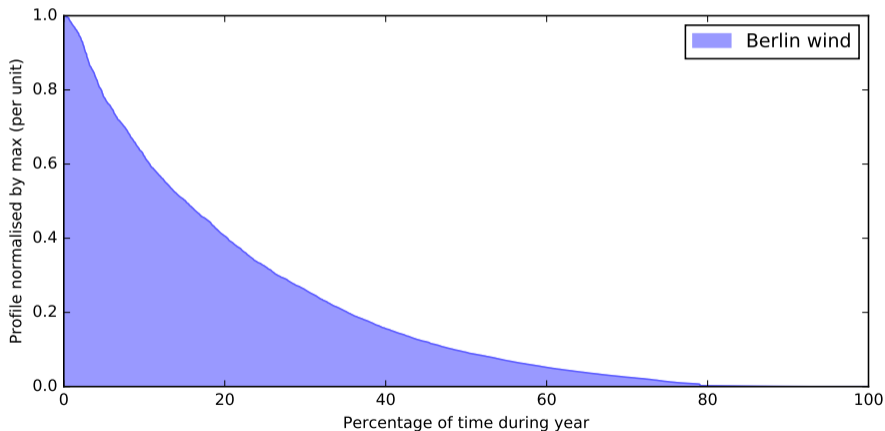

For a whole country there are fewer peaks and fewer hours with no feed-in.

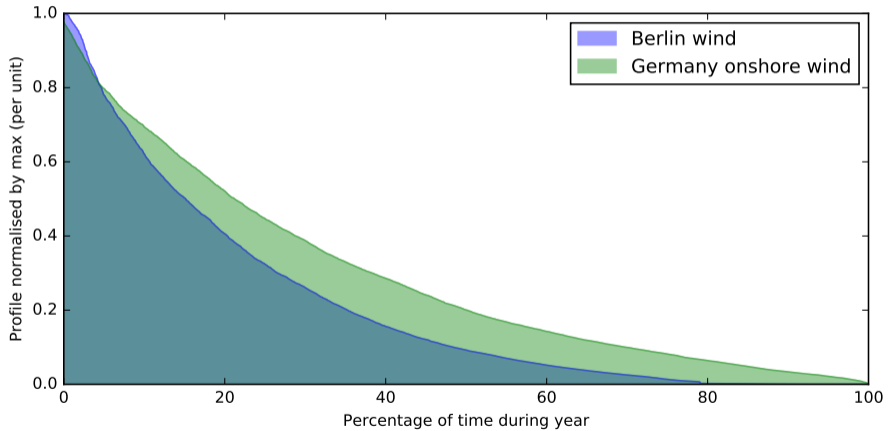

For the whole of Europe there are no times with zero feed-in.

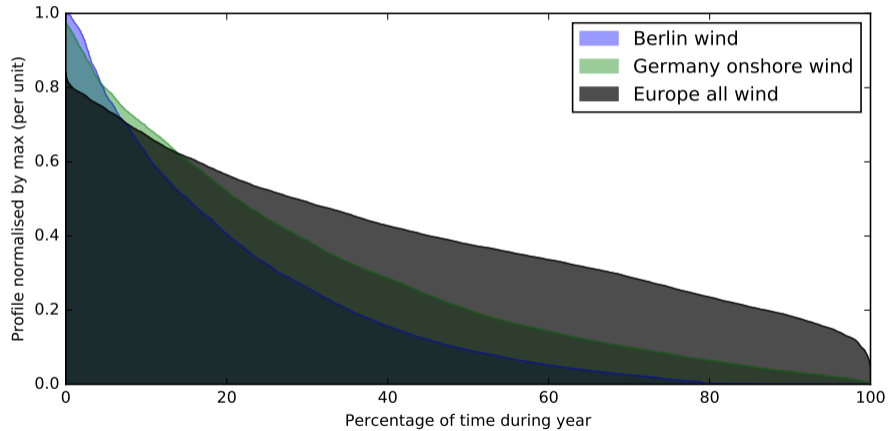

Area	Mean	Standard deviation
Berlin	0.21	0.26
Germany	0.26	0.24
Europe (including offshore)	0.36	0.19

Conclusion: Wind generation has much lower variability if you integrate it over a continent-sized area.

The **synoptic** (2-3 weeks) variations in the Fourier spectrum are also suppressed between Germany (left) and the Europe profile (right), however the seasonal variations remain.

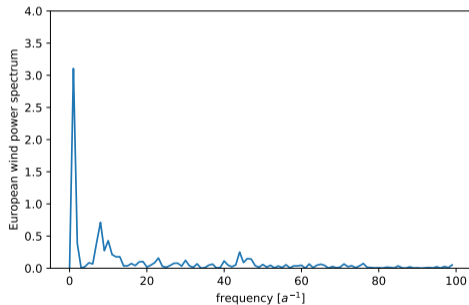
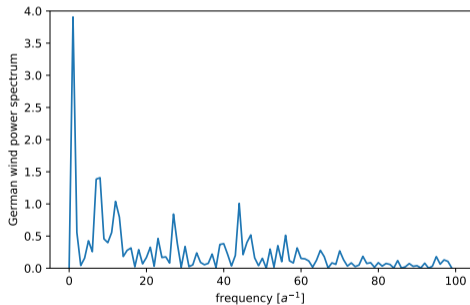

Why does this work? Consider the correlation length of wind

(a) Summer-day

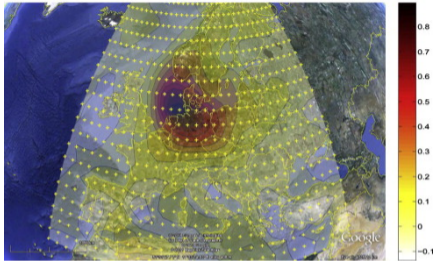

(b) Winter-day

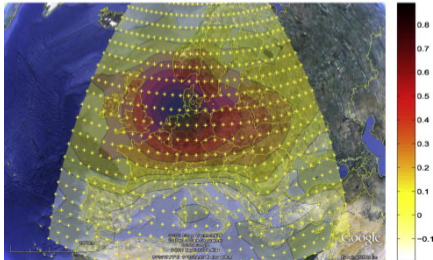

The Pearson correlation coefficient of wind time series with a point in northern Germany decays exponentially with distance. Determine the **correlation length** L by fitting the function:

$$\rho \sim e^{-\frac{x}{L}}$$

to the radial decay with distance x .

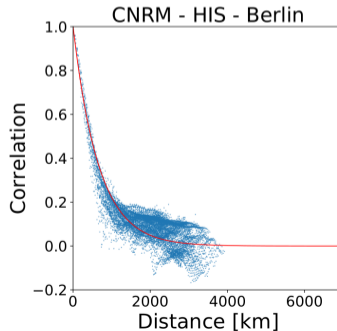

Correlation Lengths
Wind Speeds - CNRM - HIS

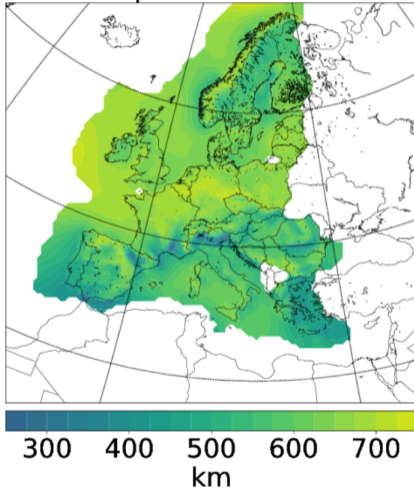

- Typically correlation lengths for wind are around 400 – 600 km.
- Smoothing requires aggregating uncorrelated sources, so need a bigger area, i.e. a continent (Europe is about 3500 km tall and 3100 km wide).
- Correlation lengths are longer in the North than the South because of big weather systems that roll in from the Atlantic to the North (in the South they get dissipated).

What sets these lengths?

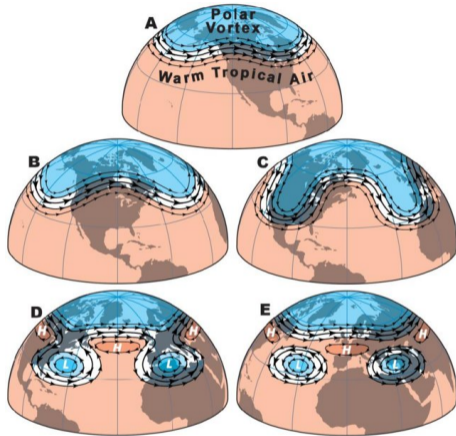

- Atmospheric **Rossby waves** are giant meanders in high-altitude winds that have a major influence on weather.
- Also found on other planets like Jupiter and Saturn (general feature of rotating fluids).

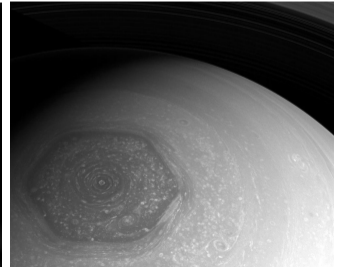
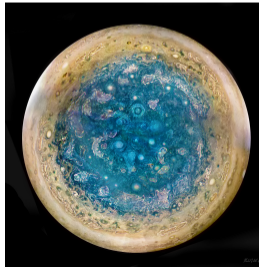

How does the mismatch change as we integrate over larger areas?

If we have for each time t a demand of d_t and a 'per unit' availability w_t for wind and s_t for solar, then if we have W MW of wind and S MW of solar, the effective **residual load** or **mismatch** is

$$m_t = d_t - Ww_t - Ss_t$$

We choose W and S such that on **average** we cover all the load

$$\langle m_t \rangle = 0$$

and so that the 70% of the energy comes from wind and 30% from solar ($W = 147$ GW and $S = 135$ GW for Germany).

This means

$$W\langle w_t \rangle = 0.7\langle d_t \rangle$$

$$S\langle s_t \rangle = 0.3\langle d_t \rangle$$

Let p_t be the balance of power at each time. Because we cannot create or destroy energy, we need $p_t = 0$ at all times.

If the mismatch is positive $m_t > 0$, then we need **backup power** $b_t = m_t$ to cover the load in the absence of renewables, so that

$$p_t = b_t - m_t = b_t - d_t + Ww_t + Ss_t = 0$$

If the mismatch is negative $m_t < 0$ then we need **curtailment** $c_t = -m_t$ to reduce the excess feed-in from renewables, so that

$$p_t = -m_t - c_t = -c_t - d_t + Ww_t + Ss_t = 0$$

At any one time we have either backup or curtailment

$$p_t = b_t - m_t - c_t = Ww_t + Ss_t + b_t - d_t - c_t = 0$$

Mismatch for Germany

Backup generation needed for 31% of the total load.

Peak mismatch is 91% of peak load (around 80 GW).

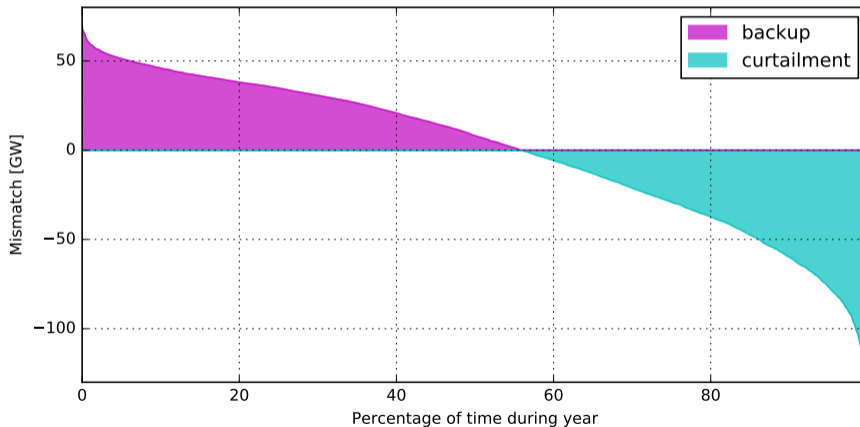

Mismatch for Europe

Requires 750 GW each of onshore wind and solar.

Backup generation needed for only 24% of the total load.

Peak mismatch is 79% of peak load (around 500 GW).

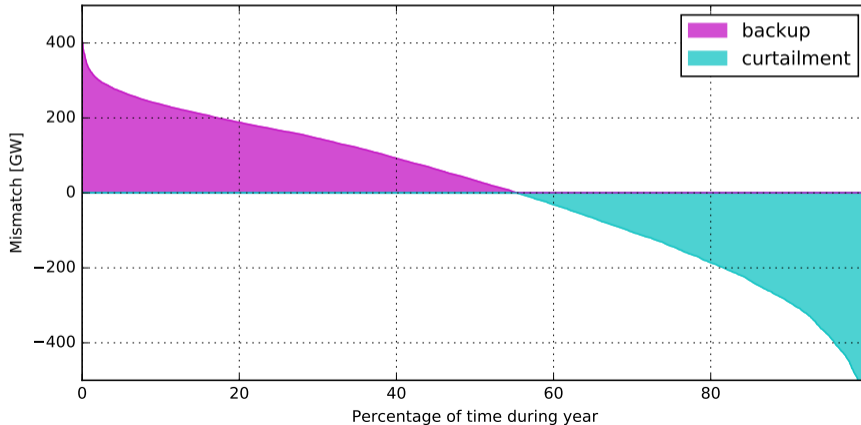

- Integration over a larger area smooths out the fluctuations of renewables, particularly wind.
- Wind backs up wind.
- This means we need **less backup energy**.
- And **less backup capacity**.

'Cost-optimal design of a simplified, highly renewable pan-European electricity system'

by Rolando A. Rodriguez, Sarah Becker, Martin Greiner, Energy 83 (2015) 658-668

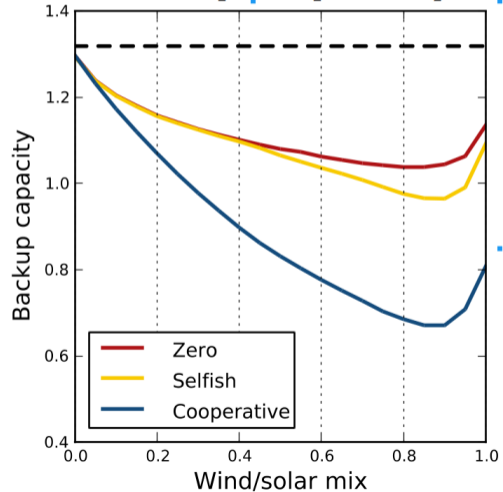
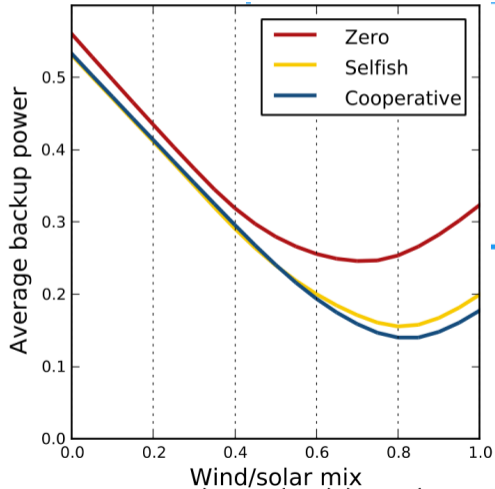

'Integration of wind and solar power in Europe: Assessment of flexibility requirements'

by Huber, Dimkova, Hamacher, Energy 69 (2014) 236e246

1-hour net load ramp duration curves at the regional, country and European spatial scales at 50% share of renewables and 20% PV in the wind/PV mix for the meteorological year 2009.

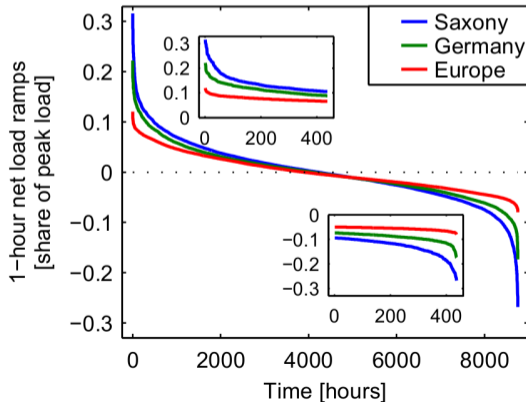

There is a big caveat to this analysis.

We've assumed that we can move power around Europe without penalty.

However, in reality, we can only transport within restrictions of the power network.

In general we will have different power imbalances $p_{i,t}$ at each location/node i and instead of $p_t = 0$ we will have

$$\sum_i p_{i,t} = 0$$

(neglecting power losses in the network).

Moving excess power to locations of consumption is the role of the network.

Electricity Networks

Electricity Transport from Generators to Consumers

Electricity can be transported over long distances with low losses using the high voltage transmission grid (losses go like I^2R , power transmission like VI , so reduce I by raising V):

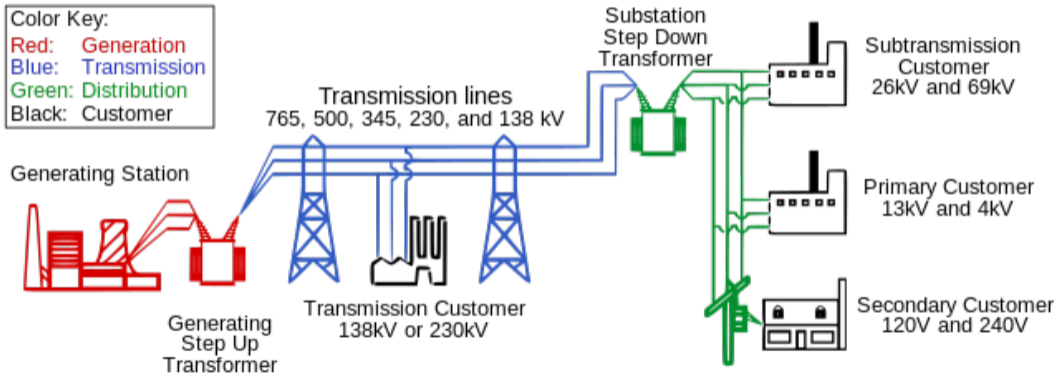

Usually in houses the voltage is 230 V, but in the transmission grid it is transformed up to hundreds of thousands of Volts.

Flows in the European transmission network must respect both Kirchoff's laws for physical flow and the thermal and/or other limits of the power lines.

Taking account of network flows and constraints in the electricity market is a major and exciting topic at the moment.



Electricity is traded in large market zones. Power trades between zones (“scheduled flows”) do not always correspond to what flows according to the network physics (“physical flows”). This leads to political tension as wind from Northern Germany flows to Southern Germany via Poland and the Czech Republic.

Figure 7: Average physical and scheduled flows [MWh/h], 01.01.2011 – 31.12.2012

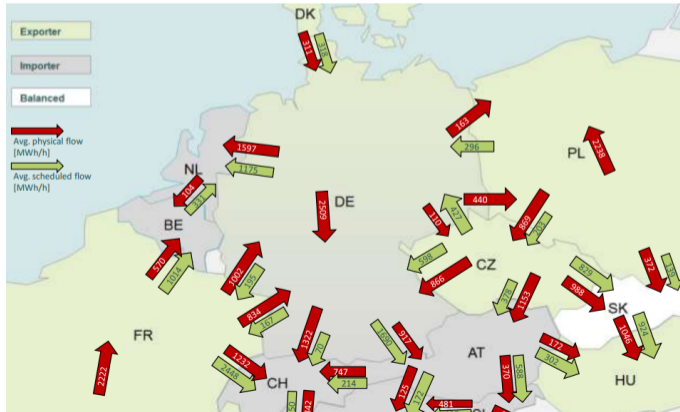

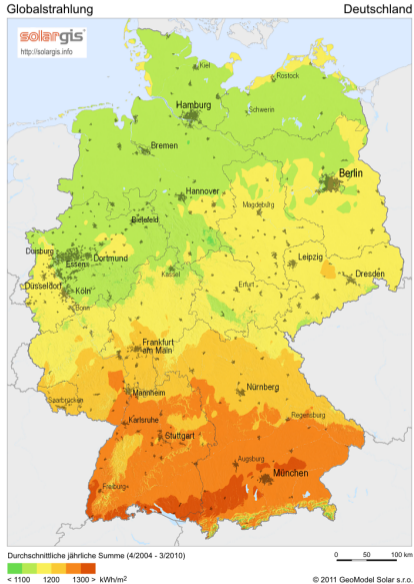

- Solar insolation at top of atmosphere is on average 1361 W/m^2 (orbit is elliptical).
- In Germany average insolation on a horizontal surface is around 1200 kWh/m^2 .
- A 1 kW solar panel (around 7 m^2) will generate around 1000 kWh/a .

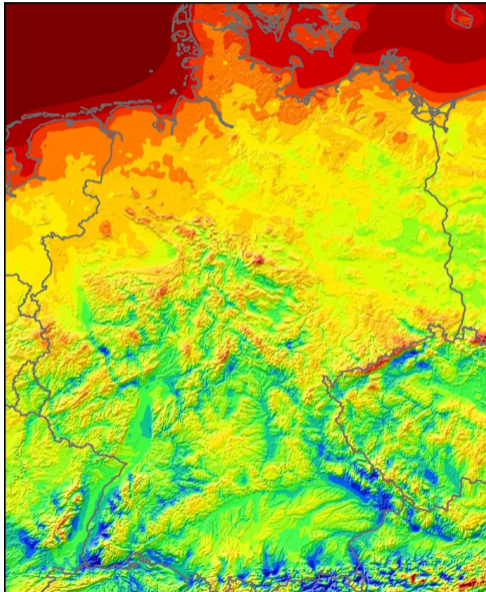

2004 - 2013

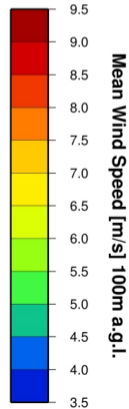

- Best wind speeds in Germany in North and on hills.
- In theory power output goes like cube $\propto v^3$ of wind speed v .
- In practice power-speed relationship is only partially cubic.

Renewables are not always located near demand centres, as in this example from Germany.

Load distribution

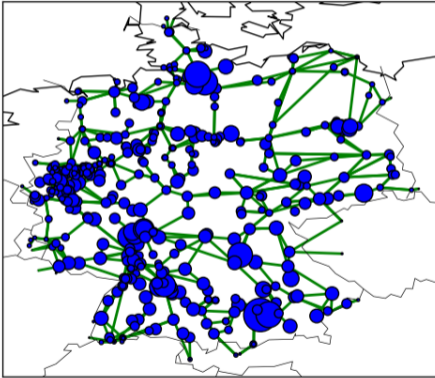

Wind Onshore

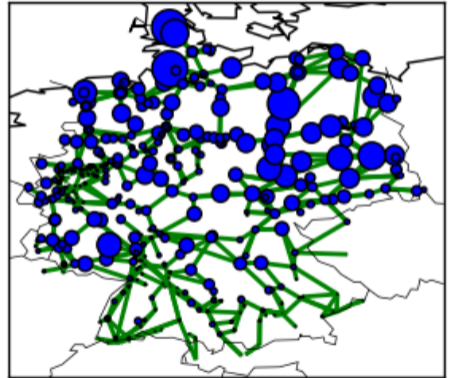



- This leads to **overloaded lines** in the middle of Germany, which cannot transport all the wind energy from North Germany to the load in South Germany
- It also overloads lines in neighbouring countries due to **loop flows** (unplanned physical flows 'according to least resistance' which do not correspond to traded flows)
- It also **blocks imports and exports** with neighbouring countries, e.g. Denmark

In a **radial** or **tree-like** network there is only one path between any two nodes on the network.
The power flow is thus completely determined by the nodal power imbalances.

Network A:



Network B:

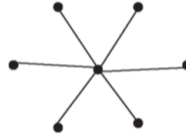

Network C:

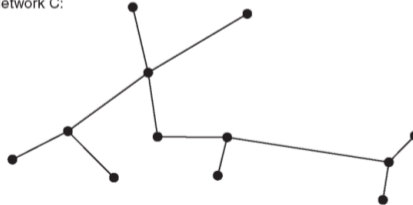

In a **meshed** network there are at least two nodes with multiple paths between them.

The power flow is now not completely determined. We need new information: the impedances in the network.

Network D:

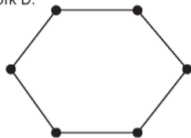

Network E:

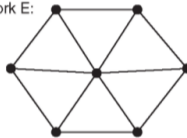

Network F:

